

CloudTouch

Interactive Intelligent Panel

Cloud Touch 55 / 65 / 75 / 86 / 98



USER MANUAL

Contents



Features.....	1
Safety Warning and Precautions.....	1
Installation and Connection.....	3
Packing List.....	3
Ports.....	4
Connection Diagram.....	5
Control Buttons on the Front Panel.....	7
Remote Control.....	7
Basic Operations.....	8
Power On/Standby.....	8
Source Selection.....	8
Menu Operations.....	8
List of Menu Settings.....	9
Intelligent Platform Operations.....	9
Basic Operations.....	11
QuickStart.....	11
Settings.....	13
Important Statement about Network Service.....	14
Troubleshooting.....	15
Technical Specifications.....	16
Toxic/Hazardous Substances/Elements in the Product.....	19



Features

- 1.Run on Android 5.0.1 operating system with unique UI design, offering you more convenient operations and better visual experience.
- 2.With high precision touch and smooth writing.

Safety Warning and Precautions

Thanks for purchasing our high-performance multifunctional LED backlight electronic whiteboard. As a valuable offering better audio and visual experience, this product has considered the personal safety factors in design and been tested strictly before delivery. However, improper installation and use may cause electric shock or fire. To ensure its safe use, maintain its service life and bring its best performance into full play, please read and understand the operating instructions and nameplates and observe the following safety precautions carefully before using the product, and keep this Manual properly for future reference.

 Warning	May cause casualties
	Prohibited actions

 Caution	May cause personal injury or property damages
	Imperative operations

In case of the

- Power outage or unstable voltage.
- Abnormal sound or smell;
- Damaged AC power cord;
- Product damage caused by fall, strike or impact;
- Any object or liquid falling into the product.



Turn off the product immediately, disconnect the power plug from the power socket and contact an authorized professional maintenance engineer for repair.

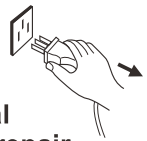

- In case of any flammable gas leakage, do not connect/disconnect the power plug of this product or any other electrical appliance but close the leaky valve and open the doors and windows immediately.

Warning

- | | |
|---|--|
| <ul style="list-style-type: none"> ● Use AC 100-240V, 50/60Hz only. ● Cut off power supply before connecting/disconnecting any cable. ● To avoid the risk of fall, damage and fire, do not fix the product to any unstable position. ● Do not place the product in any environment: <ol style="list-style-type: none"> 1. That is too damp, hot, cold or dusty or exposed to direct sunlight; | <ul style="list-style-type: none"> ● Paralleling multiple power plugs to one power outlet may cause fire due to excessive power consumption. ● To avoid the risk of electric shock and fire, keep the product away from naked flames (like burning candles). ● Do not put any container with water on the product, or the water drops or splashes could cause electric shock or fire. |
|---|--|

Safety Warning and Precautions

Warning

2. Where flammable or explosive substances are stored or used;
3. Where there are combustible or corrosive gases.
4. Like bathroom and kitchen.

● Do not use any damaged or inappropriate power outlet. Keep a good contact between the power plug and outlet.

● Protect the power plug and outlet against dust and metal attachments.

● Do not damage the power cord:

1. Do not remodel it;
2. Do not put heavy objects on it;
3. Keep it away from heat sources;
4. Do not pull it when disconnecting the power plug.

● To avoid the risk of short circuit, product damage and electric shock, do not insert any sharp object, metal or liquid into or allow them to contact the ventilation holes or signal connectors.

● It is normal that the machine appears screen mist in the process of operation, which is caused by the ambient humidity and temperature. The temperature difference between the outside glass and inside glass produce the screen mist which will disappear automatically for a period of time (standard within 24 hours). Please feel free to use it.

● The ventilation holes in the housing are designed to protect the inside components against overheat and ensure their long-term reliable work. The product should be placed without blocking such ventilation holes.



To avoid the risk of electric shock, do not touch the power plug with wet hands.



In case of rainstorm or lightning, disconnect the power plug and antenna plug immediately to protect the product against lightning stroke.



To avoid the risk of electric shock and fire, do not disassemble the product in any way. All repairs should be referred to professional technicians.

Caution

● Do not allow children to climb the product.

● To avoid the risk of swallow, keep small accessories beyond the reach of children.

● Turn off the product and disconnect the power plug before keeping the product idle for a long time for any reason.

● Disconnect all cables before changing the position or angle of the product. To avoid the risk of fall, move the product slowly.

● Do not use hard objects to rub or strike the screen or twist or press it forcibly.

● Disconnect the power plug before cleaning the product with a soft cloth without using any industrial chemical. Prevent any foreign object from falling into the product. Improper cleaning may cause damage to the appearance, erase the printed information or damage the components (if the cleaning fluid or water flows into the product) and cause display failure.)

● If the product keeps displaying one image or there is any still text or icon in a moving image during a long time, a ghosting will be left on the screen and survive long after the product is turned off. Such fault is not covered by the warranty.

● To avoid the risk of dew and fault, do not use the product immediately after moving it from a low-temperature place to a higher-temperature place.

● Cut off power supply to the product by disconnecting the power plug.

● If the leakage splashes onto your skin when the LCD screen is broken, rinse the skin with clean water for 15 minutes and seek medical advices.

● Hold the four corners and bottom side rather than exert pressure on the front panel when moving the product with hands.

● Use the product in a healthy way: use it under an appropriate light condition; insufficient light or long continuous use may damage your vision.

● The power plug or appliance coupler acting as the make and break device should be easy to operate.

● Insert the power plug into the power socket reliably. A loose connection may cause sparks or fire.

● The technical specifications provided in this Manual and on the carton are subject to change without further notice. If there is any difference between this Manual and any actual operation, such actual operation shall prevail.

Safety Warning and Precautions

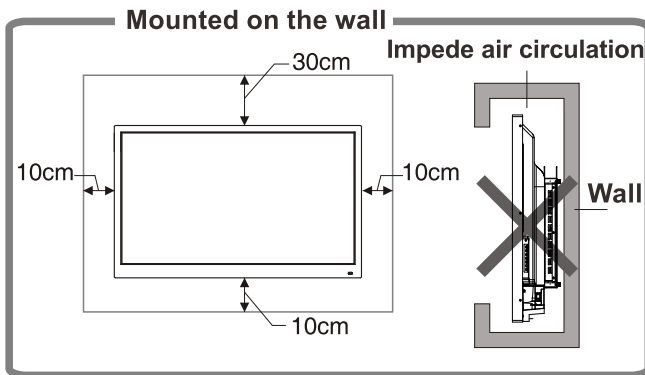

Ventilation

- Keep clearances around the product according to the minimum dimensions shown in the picture.
- Never cover the ventilation holes or insert any object into the housing.
- Do not place the product in a confined space such as bookcase or imbedded closet unless appropriate ventilation conditions are provided. There should be adequate clearances around the product to ensure good ventilation.

Installation and Connection

Packing List

Item	
Interactive Flat Panel Display x 1	●
User Manual x 1	●
Remote Control x 1	●
Warranty Card x 1	●
HDMI Cable x 1	●

Item	
Power Cable x 1	●
Touch USB Cable x 1	●
Whiteboard Pens x 2	●
AAA Batteries x 2	●
Wall Bracket x 1	●

Caution:

If you have any problem in operating, debugging or connecting the product, contact your dealer. If the product has any fault, cut off power supply immediately and contact your dealer. As a Class-A product, it may produce radio interference in living environments. In such cases, using an additional power plug as the make and break device will be a practical way to restrain interference.

Installation Tips

- Install the product near an AC power outlet with easy access.
- For the sake of safety, you are suggested to use a fitting wall-mount bracket or base for the product.
- To avoid injury, the product must be placed on a stable horizontal surface or fixed to a solid wall.
- Wall mounting of the product must be completed by a professional technician. Improper installation may cause unsteadiness of the product.
- Do not put the product in a place that may be exposed to mechanical vibration.
- Do not put the product in a place where insects may enter.
- Do not place the product directly facing an air conditioner; otherwise dew can be formed on the panel inside the display, further resulting in fault.
- Do not place the product near any strong electromagnetic field; otherwise it will be subjected to electromagnetic interference and get damaged.

Installation and Connection

Ports

CLOUD TOUCH 55/65/75/86

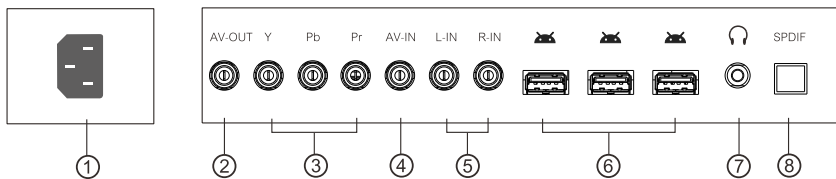

The following interface

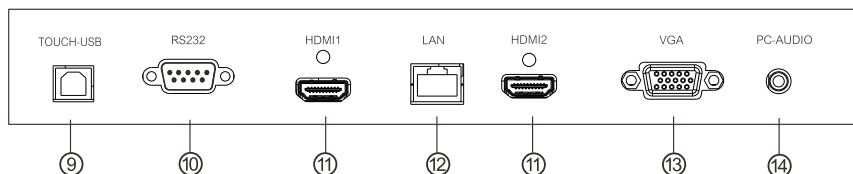

The side interface

Remark: Different models in the same series may have slightly different ports. The above pictures are subject to the actual product.

1. Ppwer Port; 2. AV-OUT Port; 3. YPbPr Ports; 4. AV-IN Port; 5. AUDIO IN Ports; 6. USB Ports; 7. Headset Port; 8. SPDIF Port; 9. TOUCH-USB Port; 10. RS232 Port; 11. HDMI Ports; 12. LAN Port; 13. VGAPort; 14. PC-AUDIO Port; 15. OPS PC-USB Ports.

CLOUD TOUCH 98

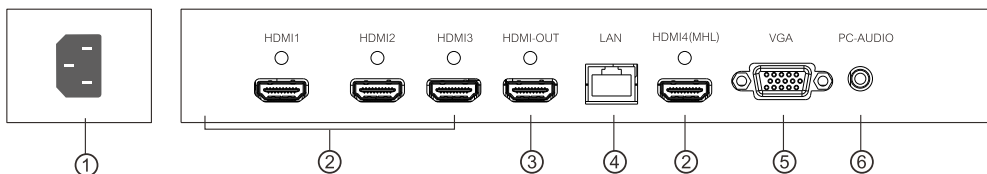

The following interface

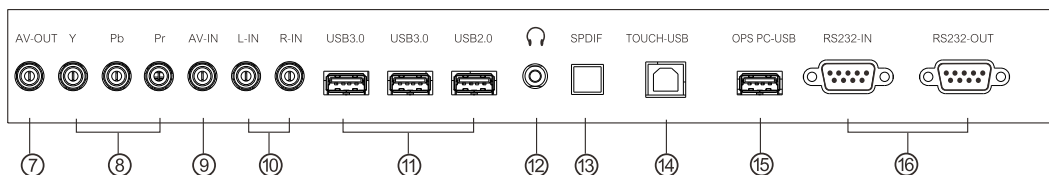

The side interface

Remark: Different models in the same series may have slightly different ports. The above pictures are subject to the actual product.

1. Ppwer Ports; 2. HDMI Ports; 3. HDMI-OUT Ports; 4. LAN Ports; 5. VGA Ports; 6. PC-AUDIO Ports; 7. AV-OUT Ports; 8. YPbPr/YCbCr Ports; 9. AV-IN Ports; 10. AUDIO IN Ports; 11. USB Ports; 12. Headset Ports; 13. SPDIF Ports; 14. TOUCH-USB Ports; 15. OPS PC-USB Ports; 16. RS232 IN/OUT Ports;

Caution: Disconnect the power plug before installing or removing the product!

Installation and Connection

Connection Diagram

Schematic diagram for connecting the product to a PC. (Note: Disconnect the power plug before installing or removing the product!)

- Connection diagram

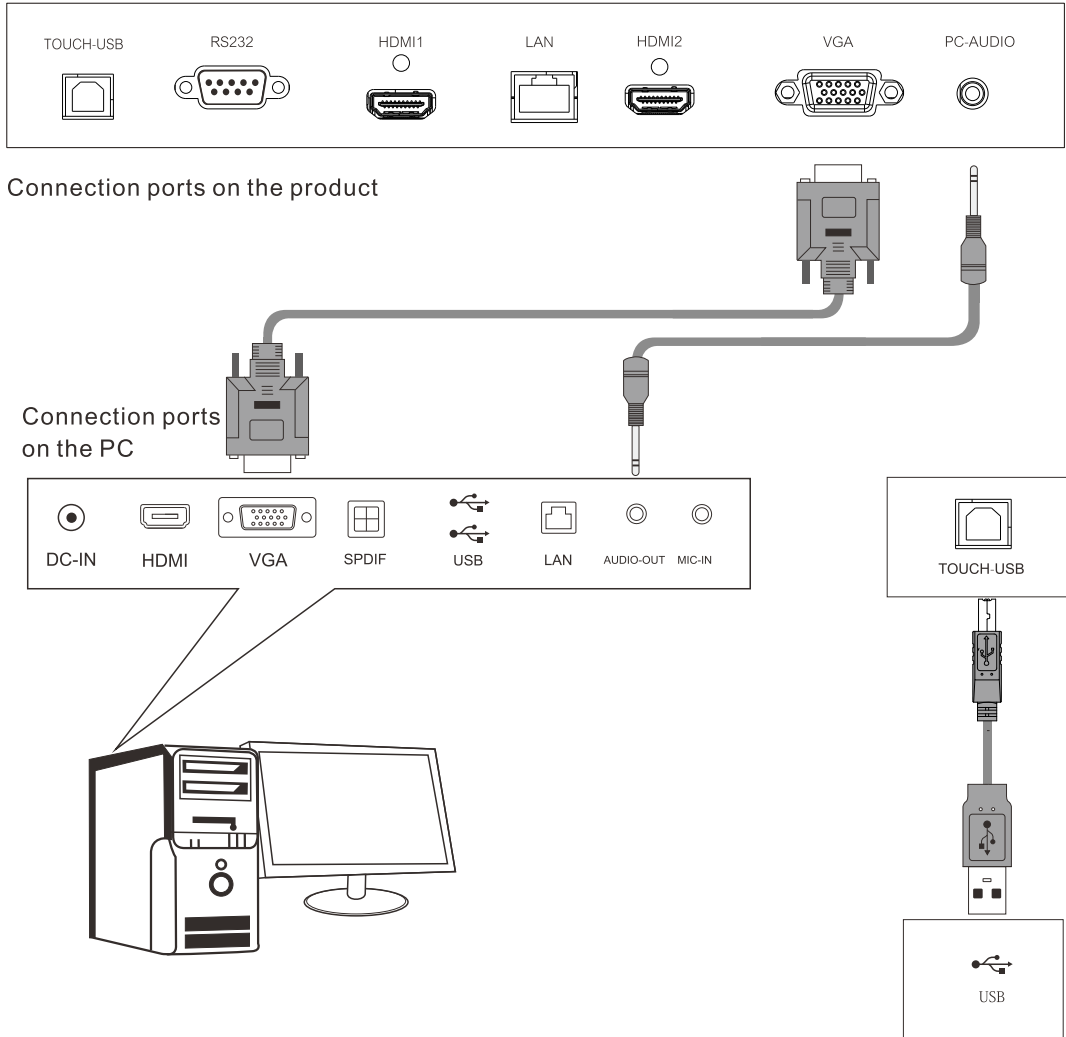



Remark: The connection diagram in this Manual is only for reference when connecting a PC box, which is subject to actual operations.

Installation and Connection

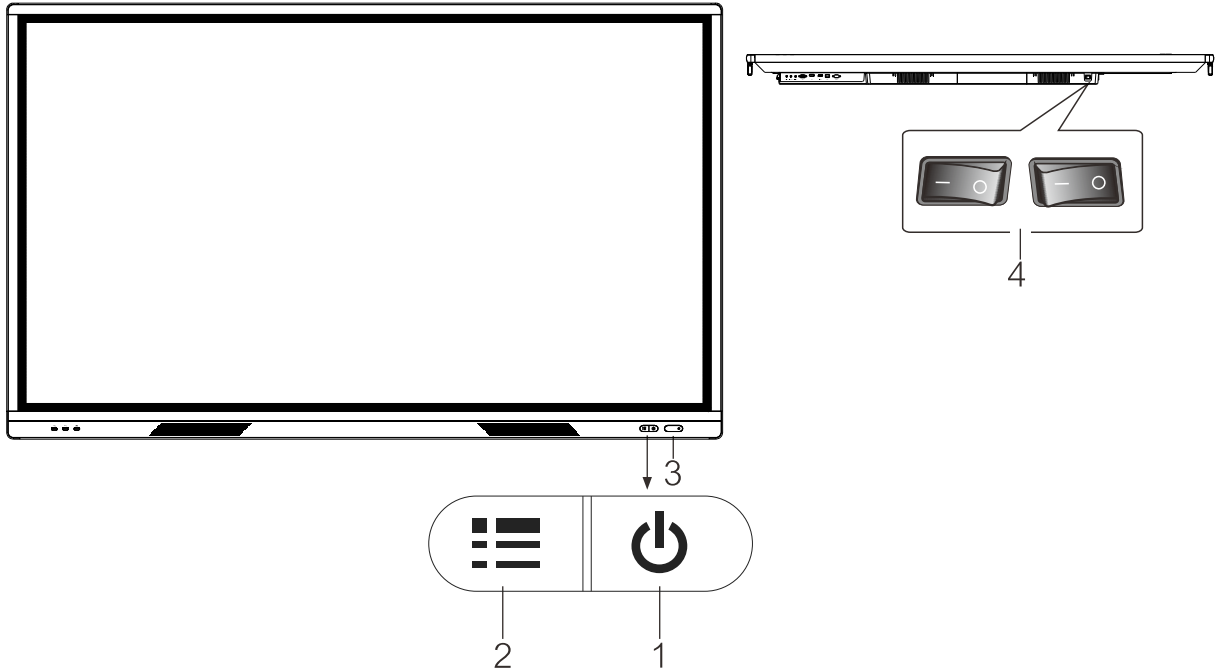
Control Buttons on the Front Panel



1.  : Power On/Standby button;
2.  : Press this button to show the Settings menu;
3. Indicator and remote receiver;
4.  : On/Off button (“I” indicates On; “O” indicates Off. This button is optional, subject to the actual product.)

Remark: Different models may have slightly different appearances. The above pictures are subject to the actual product.

Remote Control

Install Batteries in the Remote Control:

Remove the battery compartment cover and follow the polarity marks “+” and “-” in the battery compartment to install two AAA batteries (No.7, 1.5V).

Precautions for Use of Remote Control:

● Aim the remote control at the remote receiver when using the remote control. Any object placed between the remote control and the remote receiver may disturb normal operation.

Remote Control

- Protect the remote control from violent vibration. Besides, never set or place the remote control in direct sunlight because heat will result in deformation of the remote control.
- When the remote receiver on the main unit is subject to direct sunlight or strong light, it is possible that the remote control malfunctions. In such cases, please change the angle of lighting or the machine, or operate the remote control close to the remote receiver.
- Low battery voltage will affect the remote control distance. Please replace the batteries with new ones. If the remote control is to be left unused for a long period or the batteries are depleted, please remove the batteries in order to avoid battery leakage which may corrode and damage the remote control.
- Never use batteries of different types or mix a new battery with a used one. Always replace batteries in pair.
- Never try to dispose of batteries in a fire or recharge or decompose batteries. Never recharge, short-circuit, disassemble/assemble, heat or burn any used batteries. Please dispose of waste batteries according to applicable environmental regulations. Do not expose batteries to any hot environment, like direct sunlight, over the fire, etc.

Remark: The actual appearance of the remote control may be different from the picture.



Keys on the Remote Control

Key	Description
POWER (⏻)	Switch between normal operation and standby
SCREENSHOT (📷)	Take screenshot
MUTE (🔇)	Enable or disable sound
LETTER/NUMERIC KEYS	Input any number
F1 (FREEZE)	Enable or disable freeze function in the system
CH LIST (📺)	Allow backspace when inputting characters / view TV channel list
HOME (🏠)	Display the home page of the product
MENU (☰)	Display the main Settings menu
CURSOR KEYS (⬅️/➡️/⬆️/⬇️)	Select or adjust menu options
VOL +/-	Adjust volume
BACK (⏪)	Return to the previous setting interface
SOURCE	Display the source selection menu (valid only in TV mode)
CH +/-	Turn channels up/down
SOUND MODE	Select the sound mode of the product
SLEEP	Set the sleep time and auto standby when the specified time is reached
INFO	Display channel info of the product
ZOOM	Switch the channel display ratio on the screen
IMAGE	Select the picture mode of the product
SYS	Only for switching TV systems
STEREO	Select the NICAM mode of the product
OK (OK)	Confirm the operation
PLAY (▶️)	For operation of multimedia functions in the intelligent platform
PAUSE (⏸️)	
STOP (■)	
ROTATE (🔄)	
PREV (⏮️)	
NEXT (⏭️)	
BACK (⏪)	
SPEED (⏩)	

Basic Operations

Power On/Standby

Insert the power plug into the power outlet. First turn on the On/Off button “⓪” on the product, if available; then press “⏻” on the remote control or control panel to turn on the product. In the absence of the On/Off button “⓪”, just press “⏻”.

In power-on state, press “⏻”, and the product will enter standby.

Source Selection



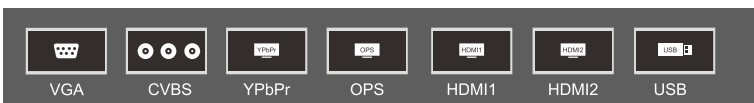











Upon startup, press “**SOURCE**” on the remote control; the screen will display the “Input Source” menu. At this moment, you can press “◀/▶” on the remote control to select a source. Press “**OK**” on the remote control; the product will switch to the input source selected.



Menu Operations

The menu operations described in this chapter are all in the LCD electronic whiteboard mode. Menu operations in other modes are basically the same. For operations in the intelligent mode, please refer to the instructions on operation of the intelligent platform below.

◆ **Description of sidebar:** First press **Source** once to show the sidebar by swiping on the right side; then press **Source** again to close the sidebar.

 (Source)		VGA Input
		AV Input
		OPS Input
		YPbPr Input
		HDMI1/2Input
	Back	
	Main Interface	
 (Toolbar)		Volume Adjustment
		Screenshot
		File Manager
		System Settings
		Notation whiteboard software
	Freeze	



Basic Operations

- ◆ Press the “MENU” key on the remote control or on the front panel; the screen will display the main menu:

 1. Press “◀/▶” on the remote control to select an adjustment category menu. Adjustment category menus include: Picture, Sound Mode Adjustment, Channel, and Settings.
 2. Press “▲/▼” on the remote control to select the desired item in the category menu.
 3. Press “OK” on the remote control to enter the item to be adjusted.
 4. Press “◀/▶” on the remote control to change the analog value or setting of the adjustment item selected.
 5. When the screen displays the main menu, press the “MENU” key to exit the main menu.
 6. During menu operation, the color of an option icon that cannot be operated in the current state will change to grey.

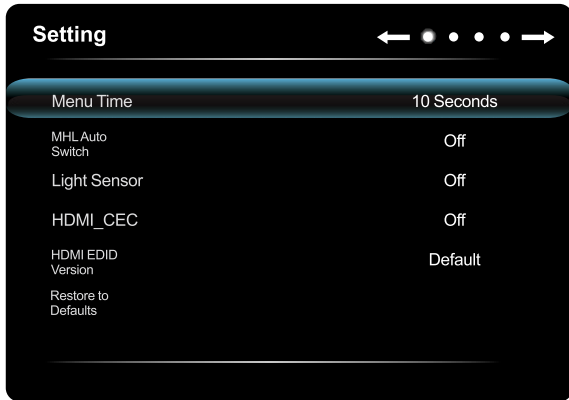
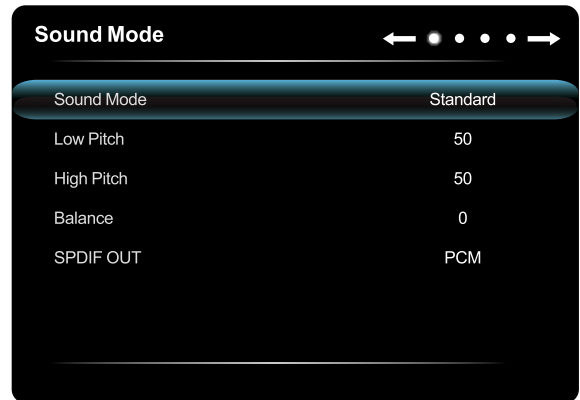
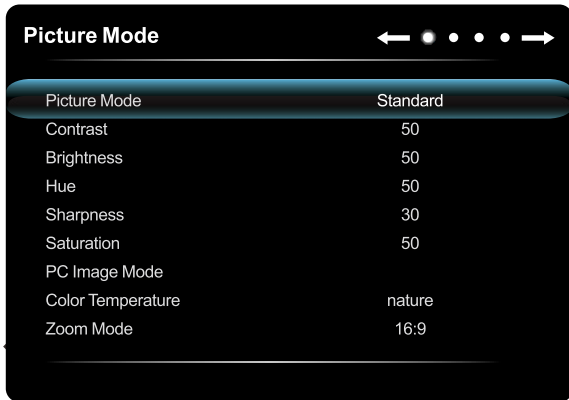

List of Menu Settings

Picture	Picture Mode	Select the picture (Standard, Bright, Soft, PC, Custom)
	Contrast	Measure the luminance between the brightest white and the darkest black that can be produced in the light and dark areas of a picture.
	Brightness	Adjust the overall brightness of pictures: increase the analog value to enhance the brightness; decrease the analog value to reduce the brightness (0-100).
	Hue	Adjust the hue of pictures: increase the analog value to change the hue to green; decrease the analog value to change the hue to purple (0-100).

Basic Operations

Picture	Sharpness	Adjust the black-white gradation of pictures: increase the analog value to improve the sharpness; decrease the analog value to reduce the sharpness (0-100).
	PC Screen Adjustment	Automatically correct the screen (valid only under VGA signal).
	Saturation	Adjust the color depth of pictures: increase the analog value to increase the color depth; decrease the analog value to reduce the color depth (0-100).
	Color Temp	Adjust the overall color temperature of pictures: Standard, Warm, and Cold.
	Zoom Mode	Adjust the aspect ratio: Full Screen, 4:3, Movie, and Subtitle.
	PC image adjustment	Adjust the image display range in PC mode (available under PC signal source).
	Remark: The analog values of Contrast, Brightness, Hue, Sharpness and Saturation are adjustable only in User Mode.	
Sound	Sound mode	Select the sound effect mode: Standard, Music, Movie, and User.
	Low Pitch	Adjust the bass level: increase the analog value to raise the bass level; decrease the analog value to lower the bass level (0-100).
	High Pitch	Adjust the treble: The bigger the analog value (0-100), the higher the treble.
	Balance	Adjust the balance between left and right channels: adjust the analog value leftward to increase the volume of left channel; adjust the analog value rightward to increase the volume of right channel (L50-R50). Generally, the balance is set to 0.
	SPDIF OUT	Select the digital sound output mode: PCM, RAW, and OFF.
	Remark: The analog values of Bass and Treble are adjustable only in User Mode.	
Settings	Meun Time	Adjust the OSD time: 5s, 10s, 15s, 20s, 30s, and Constant.
	MHL Auto Switch	Adjust MHL auto switch: two modes are available, namely, ON and OFF; it is non-adjustable only under HDMI4.
	HDMI_CEC	Adjust HDMI-CEC mode: two modes are available, namely, ON and OFF.
	HDMI EDID Version	Adjust HDMI EDID version: Default Mode, EDID1.4, and EDID2.0.
	Restore to Defaults	Restore all settings to factory defaults, and restart the system.

Remark: Different models, different sources, and the menu options may be different, please refer to the actual conditions.

Intelligent Platform Operations

Basic Operations

Press “**▲**” to display the main interface of the intelligent mode (as shown in the figure).

1. Press “**◀ / ▶ / ▲ / ▼**” to select an app;
2. Press “**OK**” to run the app;



★ Special Tips

Operations are complex in the intelligent mode; user itself can install apps. Different apps are operated differently. The app operation methods introduced in this Manual are for reference only. User shall operate the product according to the actual situation. Some functions cannot be achieved with the remote control. To ensure convenient operation, user is suggested to operate with a USB mouse and keyboard. The mouse and keyboard should be connected to the USB ports..

QuickStart

Prior to use of the product, please get familiar with the following operations to ensure a better experience.

Mouse Operation

1. **Click:** Click the mouse and then release it immediately;
2. **Long press:** Press the mouse for more than 3s; then release it;
3. Clicking the left mouse button provides the same effect as the “**OK**” key on the remote control.
4. Clicking the right mouse button provides the same effect as the “**Back**” key on the remote control.

Language and keyboard settings

Language: Select **Settings > Preferences > Language** in the intelligent mode, and press “**OK**”; press “**▲ / ▼**” to select the desired language, and press “**OK**”.

Select input method: Select **Settings > Preferences > Keyboard > Current Keyboard** in the intelligent mode, and press “**OK**”; select the desired input method in the option menu, and press “**OK**” to confirm the choice. The system is provided with “**Android Keyboard**” and “**Google Pinyin Input Method**”. User can also download a third-party input method.

System time setting: Select **Settings > Date & Time > Auto Determination of Date & Time** in the intelligent mode, and press “**OK**”. The system will automatically get the time from the network and update it. If the product is not connected to the network, you can only manually set the system time in Date & Time.

Screenshot: Before taking a screenshot, please insert the USB storage device to a USB port of the product, and press “**SCREENSHOT**” key. After taking a screenshot, the picture is stored in the “**:\Pictures\Screenshots**” folder in the USB storage device.

Intelligent Platform Operations

APK Installer: The APK Installer option helps user to manage apps. User can install setup files stored in the local disk or uninstall locally installed apps. Tip: You can access **Settings > Security & Restrictions > Unknown Sources** to set whether it is allowed to install apps not from the App Store and also set the preferred installation location or operate all apps.

◆ **How to install an app?** After entering APK installation, select Install and press “OK”. Select the path of target setup file in the local disk, and find the app installation package to be installed from the box on the right side, and press “OK”.

◆ **How to delete an app?** First select **Manage**, and press “OK”; then select the app to be uninstalled, and press “OK”; last select **Uninstall** and click “OK”; the system will automatically uninstall the app.

Multimedia Player (If the APK installer is not pre-installed, you can access the file manager to select and install the corresponding APK app): Connect the USB storage device via USB port; select **Local Play** in the main interface of intelligent mode, and press “OK” to run it. Select a file category among All, Image, Song and Video on the left side.

◆ **Play files in the local disk:** Before playing a file in the local disk, first insert the USB storage device to a USB port on the product.

Select **Local Disk** from the file directory in the middle, and press “OK”. Select Back in the directory; press “OK” to return to the previous folders; select a directory folder, and press “OK” to enter the folder; press “Back” to return to the desktop.

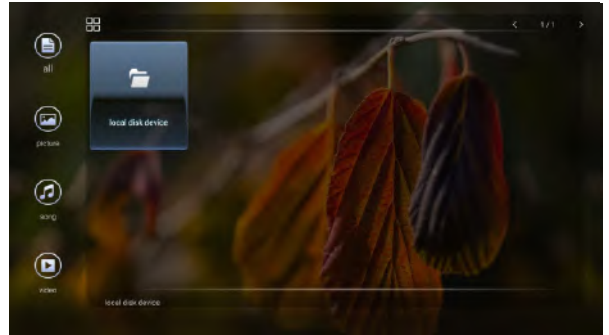

Caution:

- ① It is possible that some non-standard USB devices cannot be recognized; please use a standard USB device.
- ② The streaming media system has certain restrictions on the format of each file played; errors will be caused if going beyond such restrictions.
- ③ Do not plug or remove the USB device when the system is playing a file; otherwise system or device failures will occur.
- ④ This system supports USB flash drives, mobile hard drives and other devices with standard USB1.1 / USB2.0/USB3.0 port transmission protocols.
- ⑤ The maximum output current of USB ports on the product is 500mA; the product will enter self-protection when this limit is exceeded. If you connect an external device with heavy current, it is suggested to use an external power supply.



◆ **Description of option icons in the play interface**



Options in the image player menu

	Play the previous image.		Rotate an image leftward by 90°.
	Pause/start slide show.		Rotate an image rightward by 90°.
	Play the next image.		Show the details of an image.
	Zoom in an image.		Set image playback.
	Zoom out an image.		

Options in the song player menu







Intelligent Platform Operations

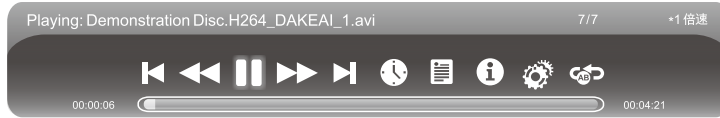



	Play the previous song.
	Pause/start music playback.
	Play the next song.

	Set the song play mode: Repeat All, Repeat One, and Shuffle.
	View the song playlist.
	Show the details of a song.

Options in the video player menu



	Play the previous chapter.
	Select the fast rewind rate.
	Pause/start video playback.
	Select the fast forward rate.
	Play the next chapter.
	Select the viewing time point

	View the playlist.
	Display the details of a video
	Playback settings; enable subtitle display and adjust audio track progress with this option.
	Set repeat play of the A-B segment. After setting points A and B, the A-B segment of the video will be played repeatedly.

During playback, press “OK” to display the menu options shown above. Select the corresponding icon, and press “OK” to execute the operation. User can press “Back” to exit playback, or press “▶ , || , ■ ◀◀ , and ▶▶” on the remote control to perform shortcut operations.

Settings

Network Settings: Select Network Settings under Settings in the intelligent mode, and press “OK”.

Wired Network Settings(Optional): Prior to use of wired network, first connect one end of the network cable to the network port on the product, and the other end to the router.

1.If your router is set to allow automatically obtaining an IP address, select Advanced Options > DHCP for IP Configuration, and press “OK”; the product will automatically obtain an IP address.

2. If your router is not set to allow automatically obtaining an IP address, you must complete network connection by the following steps (select Static in TP configuration);

3.Select **IP Address**, and configure an available IP address for the product;

4.Select **Default Gateway**, and configure an available gateway for the product;

5.Select **Network Prefix Valid Length**, and configure a valid length of subnet mask for the product;

6.Select **Preferred DNS1 and Alternate DNS2**, and configure an available DNS server address for the product;

7.Select **Save**, and press “OK”; the system will give a prompt indicating the setting is finished.

8.Select **Subnet Mask**, and configure an available subnet mask for the product;

9.Select **Default Gateway**, and configure an available gateway for the product;

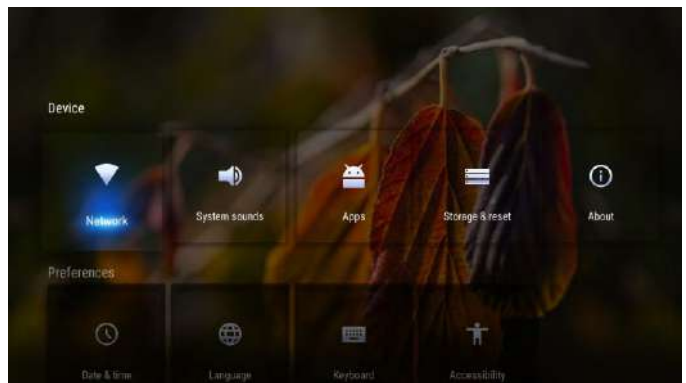

Intelligent Platform Operations

10. Select Preferred DNS1 and Alternate DNS2, and configure an available DNS server address for the product;

11. Select Save, and press “**OK**”; the system will give a prompt indicating the setting is finished.

◆ **WiFi Hotspot:** Set the product as a hotspot for wireless network connection with this option.

1. Select **WiFi Hotspot**, and press “**OK**” to enable the WiFi hotspot function;

2. Select Configure WiFi Hotspot, and press “**OK**”;

3. Enter the network name (**SSID**) in the textbox. The default name in the system is “**AndroidAP**”; you can also change it to other names;

4. Select Security; press “**OK**” to select the security type. If it is used as an open network, it is unnecessary to set any password, but any devices searching out your network can be connected to your open WiFi network. If you select **WPA PSK/WPA2 PSK** for encryption, you need to enter a protection password having more than 8 bits. When other devices search out the WiFi network you have shared, the correct password must be entered to connect your network;

5. After selecting **Encrypt**, the system will automatically configure a password for you; you can also enter a password in the password field;

6. Select **Save**, and press “**OK**” to save the setting; other **WiFi** devices within the area will search out your network during **WiFi** network search.

Caution: Please set the network password which should not be too simple.

Important Statement on Network Service

All contents and services obtained from the product are owned by third parties and protected by copyright, patent, trademark and/or other intellectual property laws. These contents and services are only for your personal non-commercial purposes, which shall not be used in a way not authorized by the content owner or service provider.

Under no circumstance shall our Company be liable for any direct, indirect or unexpected losses or damages arising from your or any third party’s access to any contents or services or any information or third-party software through this product.

Third-party services may be subject to change, removal or discontinuation without prior notice. Our Company does not represent or warrant that some services or contents will remain accessible at any time.

Our Company will not be responsible for any service related to these contents and services, or assume any liability for customer service. For any question or service request about these contents and services, please directly contact your content or service provider.

Troubleshooting

Symptom	Possible Cause	Solution
The screen does not display anything; there is no sound, and the indicator does not come on	Looseness of power plug, power connection failure	Check if the power cord is properly connected
Pictures shown on the product have dotted line or stripe interference	Signal interference caused by automobile, neon light, electric hair dryer, etc.	Do not use the electric hair dryer near the product;
Pictures shown on the PC are offset, do not cover the entire screen, go beyond the screen, or are blurred	<ol style="list-style-type: none"> 1. Improper adjustment 2. Wrong display mode 	<ol style="list-style-type: none"> 1. Use the auto adjustment function 2. Enter "PC Screen Adjustment" to adjust the horizontal or vertical position 3. Use the recommended mode
Short remote control distance, malfunction of remote control	<ol style="list-style-type: none"> 1. The remote receiver of the product is blocked by some object 2. Battery level of the remote control is low 	<ol style="list-style-type: none"> 1. Move the object to avoid blocking the remote receiver 2. Replace the battery
The product gets stuck, crashes or cannot be operated	<ol style="list-style-type: none"> 1. Too many programs are running 2. Normal operation of the product is disturbed by external environment (e.g., lightning, static electricity) 	Disconnect the product from power supply; wait for 1-2min and reconnect power supply; then restart the product
The touch is slow, and doesn't work	Too many machines run programs	Clean up a program that runs memory large or restart the product
OPS can't be turned on no display, no touch	OPS has no fixed well	Reinstall the OPS computer

Technical Specifications

Overall Specification

Model	CLOUD TOUCH 55
Physical resolution	3840 × 2160 (pixels)
Pixel pitch	0.315mm X 0.315mm
Response time	6ms
Brightness	350cd/m ²
Contrast	1200:1
Viewing angle	178° /178°
Chroma	16.7M
Control mode	Key control/infrared remote control/RS232 control
Input voltage	100-240V/AC
Power consumption	140W
Dimension (without packing)	1299mm X 811mm X 104mm
Net weight/gross weight	36.75Kg/45.95Kg
Wall mounting holes	300mm(H) × 300mm(W)
Installation method	Through the wall mounting holes (screw size: M6)
Housing material	Aluminum profile+Plastic
Environmental protection standard	All components and packing materials comply with the international environmental protection standards

Model	CLOUD TOUCH 65
Physical resolution	3840 × 2160 (pixels)
Pixel pitch	0.496mm X 0.372mm
Response time	6ms
Brightness	450cd/m ²
Contrast	1200:1
Viewing angle	178° /178°
Chroma	16.7M
Control mode	Key control/infrared remote control/RS232 control
Input voltage	100-240V/AC
Power consumption	170W
Dimension (without packing)	1510.5mm X 926.6mm X 122mm
Net weight/gross weight	51.9Kg/65Kg
Wall mounting holes	400mm(H) × 400mm(W)
Installation method	Through the wall mounting holes (screw size: M6)
Housing material	Aluminum profile+Plastic
Environmental protection standard	All components and packing materials comply with the international environmental protection standards

Technical Specifications

Model	CLOUD TOUCH 75
Physical resolution	3840 × 2160 (pixels)
Pixel pitch	0.429mm × 0.429mm
Response time	8ms
Brightness	450cd/m ²
Contrast	1200:1
Viewing angle	178° / 178°
Chroma	16.7M
Control mode	Key control/infrared remote control/RS232 control
Input voltage	100-240V/AC
Power consumption	400W
Dimension (without packing)	1736.8mm X 1055.4mm X 111mm
Net weight/gross weight	64.05Kg/83.9Kg
Wall mounting holes	600mm(H) × 400mm(W)
Installation method	Through the wall mounting holes (screw size: M8)
Housing material	Aluminum profile+Plastic
Environmental protection standard	All components and packing materials comply with the international environmental protection standards

Model	CLOUD TOUCH 86
Physical resolution	3840 × 2160 (pixels)
Pixel pitch	0.4935mm × 0.4935mm
Response time	8ms
Brightness	400cd/m ²
Contrast	1200:1
Viewing angle	178° / 178°
Chroma	1.07B
Control mode	Key control/infrared remote control/RS232 control
Input voltage	100-240V/AC
Power consumption	440W
Dimension (without packing)	1998mm X 1209mm X 152mm
Net weight/gross weight	84.25Kg/111.85Kg
Wall mounting holes	700mm(H) × 400mm(W)
Installation method	Through the wall mounting holes (screw size: M8)
Housing material	Aluminum Profile+Sheet Metal
Environmental protection standard	All components and packing materials comply with the international environmental protection standards

Technical Specifications

Model	CLOUD TOUCH 98
Physical resolution	3840 × 2160 (pixels)
Pixel pitch	0.5622mm × 0.5622mm
Response time	8ms
Brightness	500cd/m ²
Contrast	1300:1
Viewing angle	178° / 178°
Chroma	1.07B(10bit)
Control mode	Key control/infrared remote control/RS232 control
Input voltage	100-240V/AC
Power consumption	480W
Dimension (without packing)	2242mm X 1338mm X 116mm
Net weight/gross weight	135.43Kg/192.65Kg
Wall mounting holes	(300+300)mm(H) × 800mm(W)
Installation method	Through the wall mounting holes (screw size: M8)
Housing material	Aluminum profile+Sheet Metal
Environmental protection standard	All components and packing materials comply with the international environmental protection standards

Working conditions: temperature: 0°C~40°C; RH: 20%~80%; atmospheric pressure: 86kPa~104kPa.

Storage conditions: temperature: -10°C~60°C; RH: 10%~60%; atmospheric pressure: 86kPa~104kPa.

1. Supported systems: PAL + NTSC + SECAM;
2. Antenna input: 75Ω coaxial, unbalanced;
3. AV video input: 1+0.3Vp-p, RCA terminal;
4. AV audio input: 500mV RMS;
5. YPbPr/HDMI video input: 480i, 480P, 576i, 576P, 720P, 1080i, 1080P, 4K;
6. Intelligent operating system: Android 5.0.1;

VGA Display Mode

NO.	Mode	Resolution	Refresh Rate
1	VGA	720 × 400	70Hz
2		640 × 480	60Hz
3	SVGA	800 × 600	60Hz
4	XGA	1024 × 768	60Hz
5		1280 × 720	60Hz
6	WXGA	1360 × 768	60Hz
7		1600 × 900	60Hz
8	WUXGA	1920 × 1080	60Hz

Toxic/Hazardous Substances/Elements in the Product

Component	Toxic and Hazardous Substance or Element					
	(Pb)	(Hg)	(Cd)	(Cr ⁶⁺)	(PBB)	(PBDE)
Displayscreen	×	○	○	○	○	○
Housing	○	○	○	○	○	○
PCBA*	×	○	○	○	○	○
Power cord and cables	×	○	○	○	○	○
Metal parts	○	○	○	○	○	○
Packingmaterials*	○	○	○	○	○	○
Remote control	×	○	○	○	○	○
Speaker	×	○	○	○	○	○
Accessories*	○	○	○	○	○	○

This table has been prepared in accordance with SJ/T11364.

*: PCBA includes the PCB and its electronic components;

Packaging materials include the carton, EPS, etc.

Other accessories include the User's Manual, etc.

○: The content of such toxic/hazardous substance in all homogeneous materials of such component falls within the content limit specified in GB/T26572-2011.

×: The content of such toxic/hazardous substance in one or more homogeneous materials of such component goes beyond the content limit specified in GB/T26572-2011.

As shown in the above table prepared based on the data provided by our material suppliers for each type of materials and verified by us, this product contains hazardous substances. The hazardous substances contained in some materials are irreplaceable at the current technological level although we've been trying to make improvements.



The environment-friendly use period of this product is 10 years (see the pollution control symbol in the right figure).

Such use period will be maintained under the normal working conditions specified in the User's Manual only.

Indicative Description of Regulations on Recycling and Disposal of Waste Electrical and Electronic Products.

To care for and protect the earth better, please send it to a local manufacturer with nationally recognized qualification for recycling according to the national applicable laws and regulations on recycling of waste electrical and electronic products when you no longer need this product or at the end of its service life.

CloudTouch

Interactive Intelligent Panel



WARRANTY CARD

Model No: _____

SERIAL NO. _____

CloudWalker Streaming Technologies Pvt Ltd, Company incorporated in India under the provisions of the Companies Act, 1956, which owns the brand 'CLOUDWALKER' (hereby referred to as the Company) warrants to the purchaser (hereby referred to as the Customer) that the Cloud Touch carries a warranty of one year (12 months), that comprises of one year warranty on all parts including labour charges, from the date of purchase as mentioned in the purchase tax invoice.

For availing the warranty services:

- Customer can call on our **Toll Free No. 1800 102 3647** and register a call at our call centre (we are open from 9:30 am to 6:00 pm, Monday to Saturday)
- Customer has to retain and show the original purchase invoice at the time of every complaint and give a copy of it to the service engineer

For any other queries/suggestions, please write to us at: customercare@cloudwalker.tv

Warranty Terms & Conditions:

1. This warranty is not applicable if the original purchase invoice is not presented to the company's authorized service personnel during repair
2. The warranty is confined to the first purchaser of the product from the date of purchase as mentioned on the purchase invoice and is non-transferable. The warranty stands void in case of transfer of ownership of this product.
3. Warranty is applicable only on producing the purchase tax invoice which mentions the product model no & serial no. stated above
4. The warranty is void if this product is not used in accordance to the instructions given in the instruction manual.
5. The warranty does not extend to this product if damaged due to misuse, neglect, accident or improper installation. Damages caused by the pests or natural calamities are also not covered by this warranty.
6. This warranty does not cover loss or damage in transit, whether carried by the company's transport or by the purchaser.
7. The warranty is void if this product is repaired by any agency non authorized by the company
8. The warranty is void if the original serial number on this product is tampered, erased, modified or if any alteration is made
9. The warranty is void if any defect is caused due to usage of external accessories / third party accessories like batteries, adaptors, headsets, memory cards / malwares / spywares / virus / any applications other than operating system.

10. The warranty is void for any damages or defects arising due to normal wear and tear of parts, cosmetic damages like scratches, paint peel off, color fading away / color changes etc.
11. The warranty is void for any defects or damages arising due to customer induced damages, physical damages, breakages, defects arising due to high humidity and moisture conditions or liquid / solvent / any chemicals leakage in to this product while cleaning by the customer, modification or alteration of any nature made in the electrical circuitry / or physical construction of the product.
12. The company shall not be liable for any delay in rectifying the set, in the event of non-availability of the components and shall in no way be responsible for any losses direct or indirect arising out of the delay, if any.
13. The warranty does not extend to the accessories external to this product, if any, supplied with this product
14. In the event this product requires urgent attention, the purchaser should arrange to deliver the same to the nearest service center at his/her own cost
15. Warranty is not valid if this product is used for commercial purpose.
16. The company's obligation under this warranty shall be limited to repair or providing replacement of part/s only. This warranty shall not cover any consequential or resulting liability, injury, damage or loss to property or life arising directly or indirectly out of any defect in the product.
17. The company or its authorized service centre, reserves the right to retain any part/s or component/s replaced at its discretion in the event of a defect noticed in this product during the warranty period. The part/s or component/s or unit/s replaced will become the property of the company.
18. In the event of repairs / replacement of any part/s of the unit, this warranty will thereafter continue and remain in force only for the unexpired period of the warranty. Moreover, the time taken for repair / replacement and in transit, whether under the warranty or otherwise, shall not be excluded from the warranty period.
19. Warranty on applications / subscriptions / offers provided along with the products are limited to the respective service provider's terms and conditions.
20. This warranty will automatically terminate on the expiry of the warranty period, even if the product may not be in use for any time during the warranty period for any reason.
21. The warranty is issued subject to the jurisdiction of the civil courts at Mumbai only.

CAUTION

To prevent electrical shock, do not open the cabinet. There are no user serviceable parts inside. Please refer to qualified service personnel for repairs.

This product has a fluorescent lamp that contains mercury. Disposal may be regulated in your community due to environmental considerations. For disposal or recycling information, please contact your local authorities, or the Electronic Industries Alliance.

Customer's Signature: _____



Dealer Name, Signature & Stamp: _____

 CloudWalker

© CloudWalker Streaming Technologies Pvt. Ltd.
All rights reserved.



Interactive Intelligent Panel

NEED MORE HELP?

Visit: www.cloudwalker.tv
For installation & support, please contact:
Toll Free: 1800 102 3647
Email: customercare@cloudwalker.tv
Monday to Saturday - 09:30 to 18:00 hrs



CloudWalker

© CloudWalker Streaming Technologies Pvt. Ltd.
All rights reserved.

Head Office

A-503, Business Suites 9, S.V. Road, Santacruz West, Mumbai-400 054